

SUBPANEL DETAILS AND GROUNDING

V=0.31 [8] IF HEIGHT IS 4.88 [124] OR LESS
 V=0.25 [6] IF HEIGHT IS 6.75 [171] OR LARGER

0.25 [6] CLEARANCE HOLES FOR #10-32 BUTTON HEAD MACHINE SCREWS

CONFIGURATION A

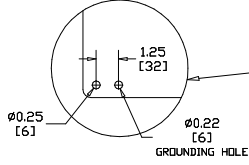
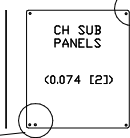

CONFIGURATION B

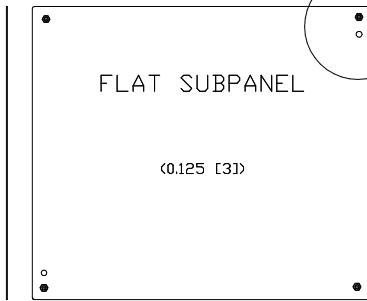

CONFIGURATION C

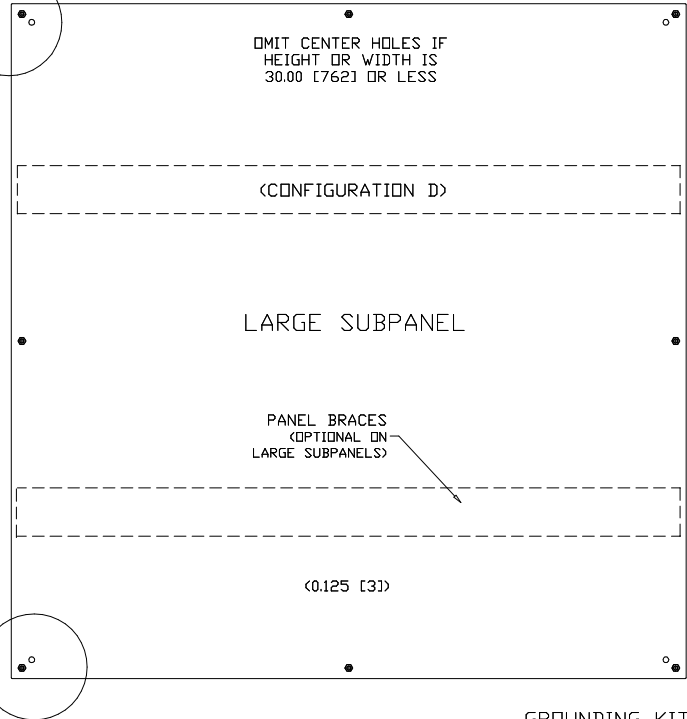
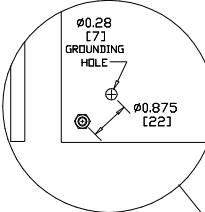
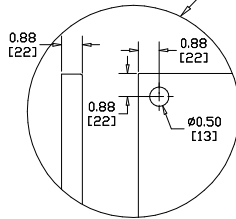

GROUNDING KIT WITH 10-32

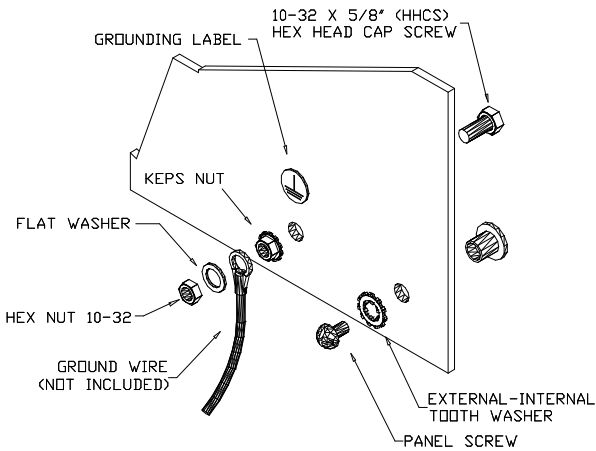

GROUNDING KIT WITH 3/8-16

