



## Table of Contents SCE-NG1870B120V

1. User Manual .....	p. 2
2. Legal Regulations .....	p. 2
3. Safety Instructions .....	p. 3
4. Controllers Used .....	p. 4
5. Controller Programming .....	p. 5
5a. IR33+ .....	p. 5
5b. DISP-1503 .....	p. 9
6. Functional Principle .....	p. 12
7. Technical Data .....	p. 13
8. Mounting .....	p. 15
9. Mounting Principle .....	p. 17
10. Cutout Dimensions .....	p. 18
11. Dimensions (H x W x D) .....	p. 18
12. Electrical Connection .....	p. 19
13. Wiring Diagram .....	p. 20
13a. IR33+ .....	p. 20
13b. DISP-1503 .....	p. 22
14. Modbus Connection .....	p. 24
15. Taking Into Operation .....	p. 25
16. Troubleshooting .....	p. 25
17. Maintenance & Cleaning .....	p. 26
18. Transport & Storage .....	p. 26
19. Parts Supplied .....	p. 27
20. Warranty / Limits of Liability .....	p. 27



## 1. User Manual

This instruction manual contains information and instructions to enable the user to work safely, correctly and economically on the unit. Understanding and adhering to the manual can help one:

- Avoid any dangers
- Reduce repair costs and stoppages
- Extend and improve the reliability and working life of the unit

**PLEASE ENSURE TO USE THE RIGHT VERSION OF THE INSTRUCTION MANUAL SUITABLE FOR YOUR UNIT**

### Intended use

The unit is to be used exclusively for the dissipation of heat from control cabinets and enclosures in order to protect temperature sensitive components in an industrial environment. To meet the conditions of use, all the information and instructions in the instruction manual must be adhered to.



#### General Danger

Indicates compulsory safety regulations which are not covered by a specific pictogram such as one of the following.



#### High Electric Voltage

Indicates electric shock danger.



#### Important Safety Instruction

Indicates instructions for safe maintenance and operation of the unit.



#### Attention

Indicates possible burns from hot components.



#### Attention

Indicates possible damage to the unit.



#### Instruction

Indicates possible danger to the environment.

## 2. Legal Regulations

### Liability

The information, data and instructions contained in this instruction manual are current at the time of going to press. We reserve the right to make technical changes to the unit in the course of its development. Therefore, no claims can be accepted for previously delivered units based on the information, diagrams or descriptions contained in this manual. No liability can be accepted for damage and production caused by:

- Disregarding the instruction manual
- Operation error
- Inappropriate work on or with the unit
- The use of non-specified spare parts and accessories
- Unauthorized modifications or changes to the unit by the user or his personnel

Saginaw Control & Engineering is only liable for errors and omissions as outlined in the guarantee conditions contained in the main contractual agreement. Claims for damages on any grounds are excluded.

### 3. Safety Instructions

Upon delivery the unit is already meeting current technical standards therefore it can be safely taken into operation. Only trained specialists are allowed to work on the unit. Unauthorized personnel must be prohibited from working on the unit. Operating personnel must inform their superiors immediately if any malfunction of the unit becomes apparent.

Please note that before starting to work on or with the unit, a procedure must be carried out inside the cabinet on which the unit is to be mounted.

Before commencing work inside the cabinet, the control cabinet manufacturer's instruction must be read with regards to:

- Safety instructions
- Instructions on taking the cabinet out of operation
- Instructions on the prevention of unauthorized cabinet reconnection

The electric equipment meets the valid safety regulations. One can find dangerous voltage (above 50V AC or above 100V DC):

- Behind the control cabinet doors
- On the power supply in the unit housing

The units have to be fused according to the type plate and the wiring diagram. Switch the unit **off** immediately if the electric power supply is interrupted.



#### **Danger Through Incorrect Work on the Unit**

Only specialized personnel are allowed to maintain and clean the unit. Regular maintenance and cleaning must be kept in order to ensure that the unit remains in perfect working condition and has a long working life.



#### **Danger from Electric Voltage**

Only specialized personnel are allowed to maintain and clean the unit. The personnel must ensure that for the duration of the maintenance and cleaning, the unit is disconnected from the electrical supply.



#### **Attention**

Damage to the unit through the use of inappropriate cleaning materials. Please do not use aggressive cleaning material.



#### **Instruction**

Damage to the environment through unauthorized disposal. All spare parts and associated material must be disposed of according to the environmental laws.

## 4. Controllers Used

There are variations of controllers with this unit. The options are as followed variation A, IR33+ controller, variation B, PJS6 controller, and variation C, DISP-1503 controller. Please find the controller on your unit and proceed to the corresponding section.



**Variation A IR33+**



**Variation B DISP-1503**

## 5A. IR33+ Controller Programming

The cooling unit is intended to be used as a complementary accessory to larger industrial equipment. The unit is used where heat needs to be dissipated from electrical control cabinets or similar enclosures in order to protect heat sensitive components. It is not intended for household use. The unit has two completely separate air circuits which ensure that the clean cabinet air does not come into contact with the ambient air which may well be dirty or polluted. Enclosure cooling units can dissipate large quantities of heat from sealed enclosures such as electrical enclosures into the ambient air and at the same time reduce the cabinet internal temperature to below that of the ambient air.

The unit can function without problems in extreme ambient conditions (e.g. dusty and oily air) with a standard operating temperature ranging between +10°C and +55°C. Units can be ordered with an additional electrical cabinet heater. For the cooling capacities and environmental ratings please refer to the type plate data.

### Controller



The display shows the temperature in the range of -50°C to +150°C (-58°F to +302°F). The temperature is displayed with resolution of tenths between -19.9° and +99.9°.

During programming, it shows the codes and values of the parameters. The display also shows icons according to occurring events.

### Display icons

Icon	Function	Description
1	Compressor relay active	
2	Alarm relay active	Flashes when activation is delayed or inhibited by protection times, external disabling, or other procedures in progress
3	Heater relay active	
4	Ambient blower relay active	
	Alarm	Flashes when alarms are active
	Heating mode	Signals operation of unit in heating mode
	Cooling mode in progress	Activated only by manual procedure

### Programming

The operating parameters can be modified using the front keypad. Access differs depending on the type of parameter. Access to configuration parameters is protected by a password that prevents unwanted modifications or access by unauthorized persons.

*Setting cooling set point, St1:*

1. Press and hold “SET” until the display shows St1. Once released the pre-set value of St1 will appear. (default: +35°C / +95°F)
2. Reach the desired value by using ▲ or ▼.
3. Press “SET” again to save the new value of St1.

*Setting heating set point, St2 (only for units supplied with internal heater):*

1. Press “SET” twice slowly and display should show St2 and then the pre-set value of St2. (default: +5°C / +41°F)
2. Reach the desired value by using ▲ or ▼.
3. Press “SET” again to save the new value of St2.

*Setting temperature units (°C / °F), low temperature alarm and high temperature alarm:*

1. Press “PRG” button for 5 seconds to reach the modifiable parameter list.
2. Use ▲ or ▼ to reach the desired parameter:
  - C18 for temperature unit of measure
  - °C = 0
  - °F = 1
  - P25 for low temperature alarm threshold (default -10°C / +14°F)
  - P26 for high temperature alarm threshold (default +55°C / +131°F)
3. Press “SET” on the desired parameter to display the current value.
4. Use ▲ or ▼ to reach the desired value.
5. Pressing “SET” temporarily saves the new value and returns to the parameters list.
6. Repeat steps 2-5 to set other parameters.
7. Press “PRG” for 5 seconds to permanently save the new values.







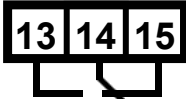

### Test Function

Different test functions can be used depending on the combination of keys pressed. Such tests run for the duration of 4 minutes.

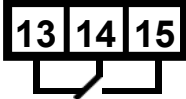
- “SET+▲” tests Compressor and Ambient Blower relays.
- “SET+▼” tests Alarms and Heater relays

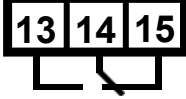
### Alarm Relay Function

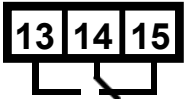
Both normally closed (NC) and normally open (NO) alarm contacts are provided. These refer to the alarm state. Under normal conditions, the NC contact is closed and the NO contact is open. When an alarm condition is present or the door contact is open, the NC contact will open and the NO contact will close. System power failure will give an alarm condition.

State	Alarm Relay	Display
1 System powered OFF		
2 System powered ON -NO ALARM -Door Contact Closed		
3 System powered ON -Door Contact Open		
4 System powered ON -ALARM STATE		

#### Notes:

State 2: Additional icons (1,3,4, Reverse, Direct, Test) depending on operation.

State 3: The display shows “OFF” alternating with the standard display.

State 4: The display shows “EXX” alternating with the standard display – at the same time, the alarm icon flashes.

Failure table:

The display shows either "OFF" or "EXX" with an icon flashing (triangle), alternating with the standard display. If more than one error occurs, these are shown in sequence on the display.



Failure Code	Description	Solution
OFF	Door open	Close the enclosure door and check the door contact switch. If no door contact switch is used and c68=0, bridge terminals on power connector.
	Incorrect phase sequence (3-phase units)	Displayed on power-up. Check phase sequence.
E01	Failure internal temperature sensor	Check probe connections.
E02	Failure ambient temperature sensor	Check probe connections.
E04	High temperature alarm	The measured temperature has exceeded the threshold P26. Check rating of the cooling unit. Clean air filters, condenser; check fans' and compressor's correct operation. Contact your service partner.
E05	Low temperature alarm	The measured temperature has fallen below the threshold P25.
E07 / E08	Controller error	Contact your service partner.

Typical alarm codes:

#### Error Code Description

E01	Probe B1 fault
E02	Probe B2 fault
E04	High temperature alarm
E05	Low temperature alarm

#### Important Notes

- Whilst programming, if no button is pressed for 10 seconds, the display starts flashing, and after 1 minute returns to the main display without saving changes.
- To increase scrolling speed, press and hold the ▲ or ▼ button for at least 5 seconds.
- When pressing "PRG" for 3 seconds, the firmware revision code is displayed for 2 seconds.
- When cleaning the controller panel, do not use ethanol, hydrocarbons, ammonia or their by products. Use neutral detergents and water.
- In order to protect the unit's components, minimum relay output on (3 or 7 minutes) and off (4 minutes) times and minimum time (7 or 11 minutes) between activation of the same relay output are applied.
- In case of digital inputs not configured, probes not fitted or configured, or St2 not enabled on the controller the display shows 'nO'.



## 5B. DISP-1503 Controller Programming

The cooling unit is intended to be used as a complementary accessory to larger industrial equipment. The unit is used where heat needs to be dissipated from electrical control cabinets or similar enclosures in order to protect heat sensitive components. It is not intended for household use. The unit has two completely separate air circuits which ensure that the clean cabinet air does not come into contact with the ambient air which may well be dirty or polluted. Enclosure cooling units can dissipate large quantities of heat from sealed enclosures such as electrical enclosures into the ambient air and at the same time reduce the cabinet internal temperature to below that of the ambient air.

The unit can function without problems in extreme ambient conditions (e.g. dusty and oily air) with a standard operating temperature ranging between +10°C and +55°C (+50°F and +131°F). Units can be ordered with an additional electrical cabinet heater. For the cooling capacities and environmental ratings please refer to the type plate data.

### Controller



### Buttons LED Functions

<input type="checkbox"/> Menu	Blue LED: Steady On - Cooling mode
<input type="radio"/> Set	Blue LED: Blinking - min. comp. off time not elapsed
<input type="triangle-up"/> Up	Red LED: Blinking - Alarm
<input type="triangle-down"/> Down	

The display shows the temperature in the range of -30°C to +110°C (-22°F and +230°F). The temperature is displayed with a resolution of 0.1° between -9.9° and +110°, and 1° between -30° and -10°. On start-up, the screen shows the unit's internal temperature and this is considered the Home Menu of the controller.

### Programming Quick Reference

Description	Input
Test Function	Press <input type="triangle-up"/> and <input type="triangle-down"/> simultaneously for 3 seconds
Change Cooling Setpoint	Press <input type="checkbox"/> and then <input type="triangle-up"/> or <input type="triangle-down"/> to go to Ct_S Press <input type="triangle-up"/> or <input type="triangle-down"/> to desired set point Press <input type="radio"/> to lock set point
Change High Alarm	Press <input type="checkbox"/> and then <input type="triangle-up"/> or <input type="triangle-down"/> to go to HA_S Press <input type="triangle-up"/> or <input type="triangle-down"/> to desired set point Press <input type="radio"/> to lock set point
Change Celsius/Fahrenheit	Press <input type="checkbox"/> and then <input type="triangle-up"/> or <input type="triangle-down"/> to go to C_F Press <input type="triangle-up"/> or <input type="triangle-down"/> to desired set point Press <input type="radio"/> to lock set point

### I) Operations from Home Screen

- Pressing  $\Delta$  or  $\nabla$  for 1 second will go to Menu 1. This will show the status of DI1, DI2, S1, S2 and Onboard Sensor. Pressing  $\nabla$  or  $\Delta$  will toggle between sensors/digital inputs.
- Pressing  $\square$  will go to Menu 2.
- Any Alarms will appear on the Home Screen.
- If the Door Contact is Open, the Home Screen will show an OFF status.
- Pressing  $\Delta$  and  $\nabla$  simultaneously for 3 seconds will start Test Mode.

### II) Operations from inside the Menus

- Pressing  $\square$  from any menu will return to the Home Screen.
- Pressing  $\circ$  while in Menus 2/2 shows the parameter value.
- Pressing  $\circ$  for 3 seconds while showing a parameter, will save the parameter.
- Pressing  $\square$  while showing a parameter, will return to the respective menu.

All parameters are sorted in 2 separate menus below

#### Menu 1

Parameter	Description	Range
Sbrd	Onboard Sensor Reading	-
S1	S1 Sensor Reading	-
S2	S2 Sensor Reading	-
d1	Digital Input 1 Reading	0: Open 1: Closed
d2	Digital Input 2 Reading	0: Open 1: Closed

#### Menu 2

Parameter	Description	Input	Setting range
Ct_S	Control Setpoint	$\Delta$ or $\nabla$ to Increase/Decrease Temperature	Min: ccS1 Max: ccS2
HA_S	High Alarm Setpoint	$\Delta$ or $\nabla$ to Increase/Decrease Temperature	Min: HAS1 Max: HAS2
LA_S	Low Alarm Setpoint	$\Delta$ or $\nabla$ to Increase/Decrease Temperature	Min: LAS1 Max: LAS2
Ht_S	Heater Setpoint	$\Delta$ or $\nabla$ to Increase/Decrease Temperature	Min: HS1 Max: HS2
C_F	Celsius / Fahrenheit	$\Delta$ or $\nabla$ to change between °C and °F	C: Celsius F: Fahrenheit
IP_1	Input 1 Invert	$\Delta$ or $\nabla$ to changes between NC/NO door contact	0: NC 1: NO
StAt	System State	Read Only	OFF: Off IdL: Idle CL: Cooling Ht: Heating tSt: Test
OUtP	Relay Outputs	Read Only	H: Heater Relay A: Ambient Blower Relay C: Compressor Relay

**Alarm codes**

Alarm Code	Description
AL1 - HI	High Temp Alarm
AL2 - LO	Low Temp Alarm
AL3 - PrEP	Pressure Pipe Alarm
AL4 - AbS	Ambient Sensor Faulty
AL5 - PPS	Pressure Pipe Sensor Faulty
AL6 - ICES	Ice Sensor Faulty
AL7 - InS	Internal Sensor Faulty
NA	Not Available
AL9	...Check 'Digital Input 2' Table below
AL10 - ICE	Ice Algorithm Active
AL11 - SLOC I	Incorrect Sensor Location

**Digital Input 2 Table**

dIn2	Generic Error
PH_F	Phase Failure
Pr_S	Pressure Switch
FL_S	Float Switch

**Digital Input 2 Table**

- Test mode is started by simultaneously pressing  $\triangle$  and  $\nabla$  for 3 seconds from the Home screen.
- When Test run is active, tESt will be shown blinking on the display

Test procedure when Internal Temperature is between 10°C and 50°C (50°F and 122°F)

0 to 30 seconds	Ambient Blower
30 seconds to 5:30 Minutes	Ambient Blower + Compressor
5:30 Minutes to 6:30 Minutes	Ambient Blower + Heater

## 6. Functional Principle

The cooling unit for enclosures works on the basis of a refrigeration circuit consisting of four main components: compressor, evaporator, condenser and expansion device.

The circuit is hermetically sealed and R134a refrigerant circulates inside it (R134a is chlorine free and has an Ozone Destruction Potential [ODP] of 0 and a Global Warming Potential [GWP] of 1430). The compressor compresses the refrigerant (thus taking it to high pressure and high temperature), and pushes it through the condenser, where it is cooled by ambient air thus passing from the gas to the liquid state. At the liquid state it then passes through the capillary pipe being a much lower pressure the refrigerant arrives to the evaporator where it absorbs the necessary heat to change from liquid to gas state. The gas is then drawn back into the compressor completing the cycle.

1. Air Intake, Cabinet Side
2. Radial Fan, Cabinet Side
3. Evaporator
4. Air Outlet, Cabinet Side
5. Compressor

6. Air Intake, Ambient Side
7. Radial Fan, Ambient Side
8. Condenser
9. Air Outlet, Ambient Side
10. Filter Dryer
11. Expansion Valve

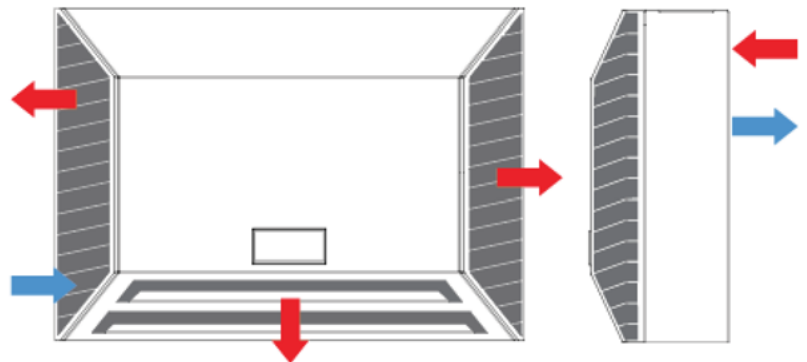
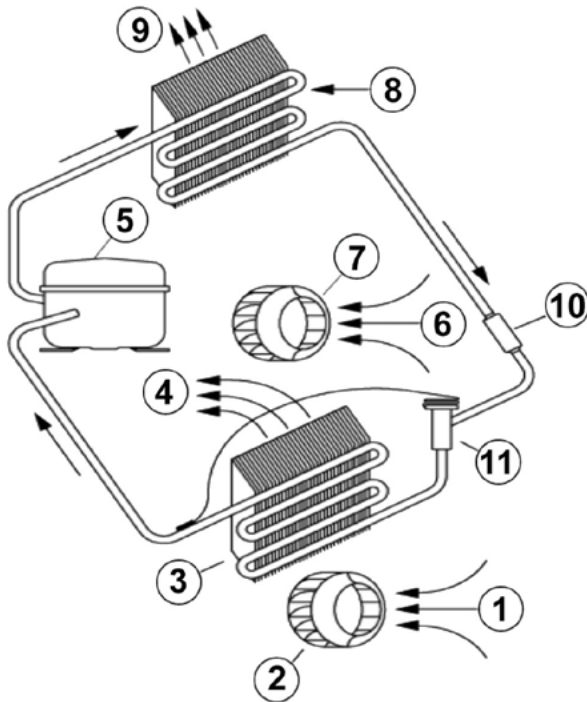

## 7. Technical Data

<b>Part Number</b>	<b>SCE-NG1870B120V</b>	
<b>Cooling Capacity @ 95°F / 95°F</b>	<b>1880 BTU</b>	
<b>Cooling Capacity @ 95°F / 131°F</b>	<b>375 W @ 50 Hz</b>	<b>375 W @ 60 Hz</b>
<b>Compressor</b>	<b>Rotary piston</b>	
<b>Refrigerant / GWP</b>	<b>R134a / 1430</b>	
<b>Refrigerant Charge</b>	<b>98 g / 3.46 oz</b>	
<b>High / Low Pressure</b>	<b>363 / 87 psi</b>	
<b>Operating Temperature Range</b>	<b>50°F - 140°F</b>	
<b>Air Volume Flow (System / Unimpeded)</b>	<b>Ambient Air Circuit: 76 / 240 cfm</b>	<b>Cabinet Air Circuit: 40 / 106 cfm</b>
<b>Mounting</b>	<b>Wall Mounted / Recessed</b>	
<b>Housing Material</b>	<b>Mild Steel, Powder Coated</b>	
<b>Dimensions (H x W x D)</b>	<b>14.6 x 20.5 x 6.2 inch</b>	
<b>Weight</b>	<b>35.3 lbs</b>	
<b>Rated Operating Voltage / Frequency</b>	<b>120 V ~ 60 Hz</b>	
<b>Rated Current @ 95°F / 95°F</b>	<b>3.6 A</b>	
<b>Starting Current</b>	<b>13 A</b>	
<b>Max. Current</b>	<b>4.8 A</b>	
<b>Nominal Power 95°F / 95°F</b>	<b>440 W</b>	
<b>Max. Power</b>	<b>580 W</b>	
<b>Fuse Rating</b>	<b>15 A (T)</b>	
<b>Circuit Breaker</b>	<b>MCB Type D or K</b>	<b>15A [Slow Acting]</b>
<b>Connection</b>	<b>5 pole terminal for signals</b>	
	<b>4 pole terminal for power</b>	
	<b>3 pole terminal block for RS 485 Modbus</b>	
<b>NEMA Protection Class</b>	<b>Type 3, 3R, 12, 4</b>	
<b>Approvals</b>	<b>CE, cURus, cULus</b>	

### Short Circuit Current Rating for Air Conditioners and Heat Exchangers

As per UL508A Supplement SB, Seifert Systems' air conditioners have a default SCCR of 5 kA.

If no additional measures are taken in the installation, the resulting SCCR rating in the control panel would be 5 kA, assuming that the air conditioner is the lowest rated component in the panel.

However, a high fault SCCR is conditional on the use of specific over current protective devices.

Table SB4.2 (UL508A) lists the Fuse Peak let through currents,  $I_p$ , and clearing,  $I_{2t}$ , based on available short circuit current levels for a number of fuse types. A high fault SCCR can be achieved with the use of a time delay fuses such as Class CC. The current limiting fuse used must have a SCCR higher or equal than that of the panel. Additionally, the let through current  $I_p$  of the fuse must be less than 5 kA. The fuses must be marked as Current Limiting and the let through current must be verified from the manufacturer's curves. Refer to the unit's type plate data for fuse rating

Article 409 of the 2008 National Electric Code (NFPA 70) requires industrial control panels to be marked with a short circuit current rating. As specified in the National Electric Code, UL508A-2001 Supplement SB, the Standard of Safety for Industrial Control Equipment, provides an accepted method for determining the short-circuit current rating of the control panel.

The SCCR rating for our air conditioners and heat exchangers has a default value of 5 kA.

You may use a 5 or 10 kVA isolation transformer between the customer's panel and our air conditioner and not have an effect on the customer's 65kA rating. You may use a fuse or circuit breaker with a 5 kA short circuit rating on the line side of the ACU and its branch circuit protective device and not have an effect on the customer's 65 kA rating.

The current limiting fuse or circuit breaker used on the line side of the branch circuit protection for the ACU must have a SCCR => that of the panel rating. Additionally for a current limiting fuse the customer would need to verify using table SB4.2 of UL 508A, that the let through current ( $I_p * 103$ ) of the fuse is  $\leq 5$ KA. If a circuit breaker is used as feeder protection, it must be marked Current Limiting type from the manufacturer, and the panel builder would need to verify based on the manufacturers published curves that it will let through  $\leq 5$ KA. Examples of these curves are included in UL 508A supplement SB.

You can run separate circuits for the panel and the air conditioner as long as each is labeled with their individual SCCR ratings. (5 kA and 65 kA) If the customer does not implement one of the options above, then the resulting SCCR rating would be the 5 kA rating of the ACU, if that is the lowest rated component in the panel.

Testing represents another option; however, if the customer does not implement these options, then the resulting short circuit rating of the panel is based on the lowest short circuit current rating of all power circuit components installed in the panel.

### NEXTGEN ENVIRO-THERM® AIR CONDITIONERS 1870 BTU/HR PERFORMANCE CURVE

SCE-NGI870BI20V, SCE-NGI870B230V

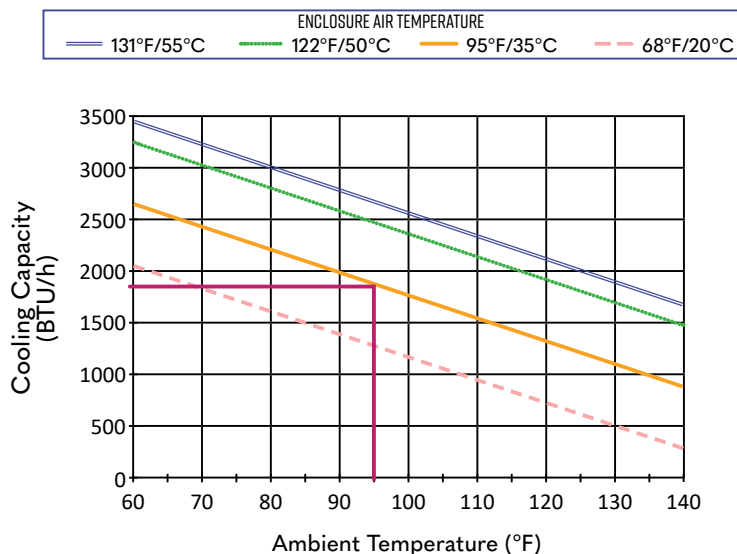

## 8. Mounting



The power supply rating on unit rating plate must comply with mains rating.



Always disconnect the power supply before opening the unit.

Heat load to be dissipated from enclosure should not exceed specific cooling output of the unit at any condition. When selecting a cooling unit, always allow for a safety margin of at least 15% extra cooling output in the worst conditions.

Air inlets and outlets must be completely free from obstruction. Ensure that flows of air leaving and entering the cooling unit, internal and external, are not obstructed. It must also be ensured in accordance with UL, that the air outlet is not blowing air directly at an equipment operator. Should this be the case a barrier or duct shall be provided to redirect the airflow.

Cooling unit enclosure air suction hole must be installed at the highest possible point. When installing the unit on a door ensure it can take the weight.

Before drilling the enclosure, ensure the fixing elements and couplings will not interfere with the equipment inside the enclosure itself. Disconnect power before starting any work inside the enclosure.

Following the Drilling Template, drill the holes and make the required cuts on the enclosure. This template may have been affected by storage conditions, please check this template by verifying values of the largest dimensions before drilling. Fit the sealing strip to the cooling unit on the side connected to the enclosure and follow the installation diagram.

If the unit is mounted in a recessed position, the controller bracket can be pulled according to the wall thickness of the enclosure outwards as per steps below.

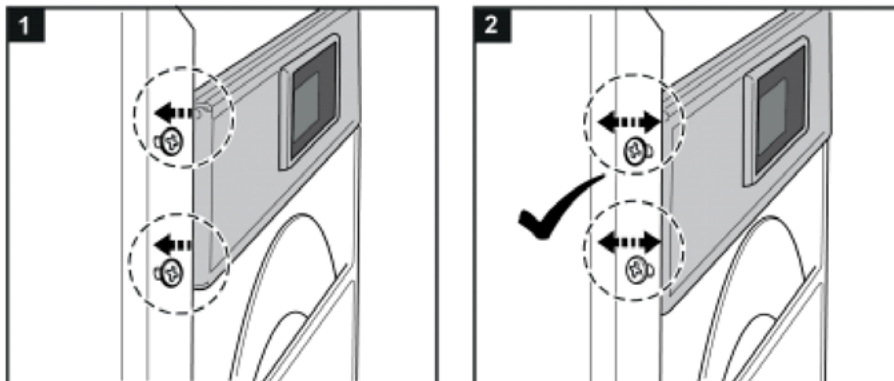

### Condensate Management:

High humidity and low temperatures inside the enclosure can lead to condensation on the evaporator. Condensate that flows back into the enclosure can damage sensitive control electronics. The integrated condensate evaporation of the cooling unit releases the condensate to the environment. If condensate formation is too great, additional condensate can drip into an overflow trough, which then drains off on the ambient side. In order to prevent the formation of excessive condensate, you should nevertheless:

- Check the seals at regular intervals
- Consider installing a door contact switch. This can prevent condensation forming when enclosure door is left open.



**Filter installation:**

If you install / replace a filter please follow the steps below.

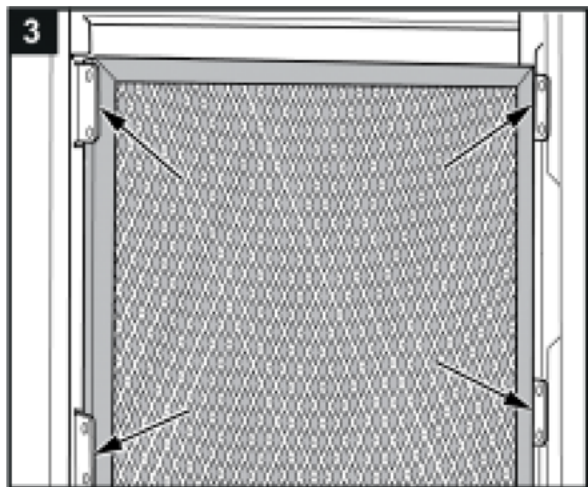
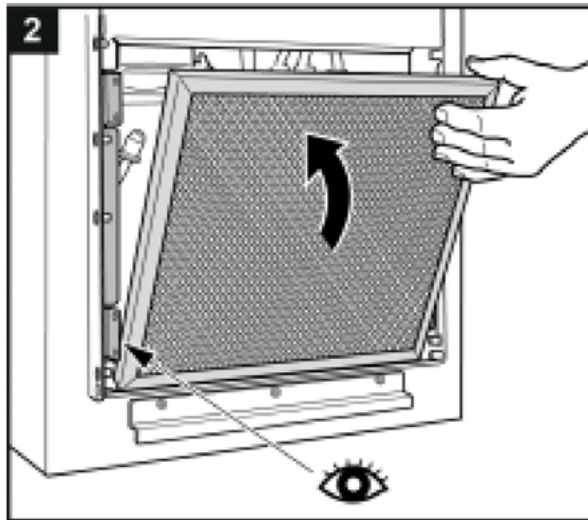
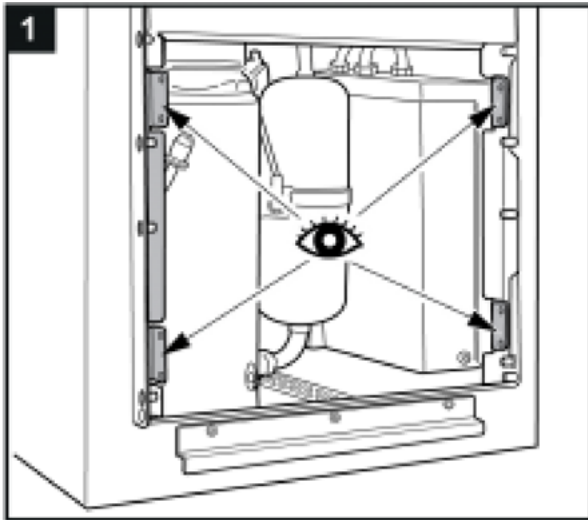



## 9. Mounting Principle



- Do not use within the first 15 minutes after installation!
- Use only the supplied mounting hardware.
- Tighten fasteners to 40 inch lb.
- Ensure the mounting surface does not warp after assembly and reinforce it if necessary.

- 1 M6 screws
  - 2 M6 toothed washers
  - 3 M6 flat washers
  - 4 Enclosure
  - 5 Mounting gasket
  - 6 Lifting hook
  - 7 Cover
  - 8 M4 screws
- Fig. 1 Recessed  
Fig. 2 External

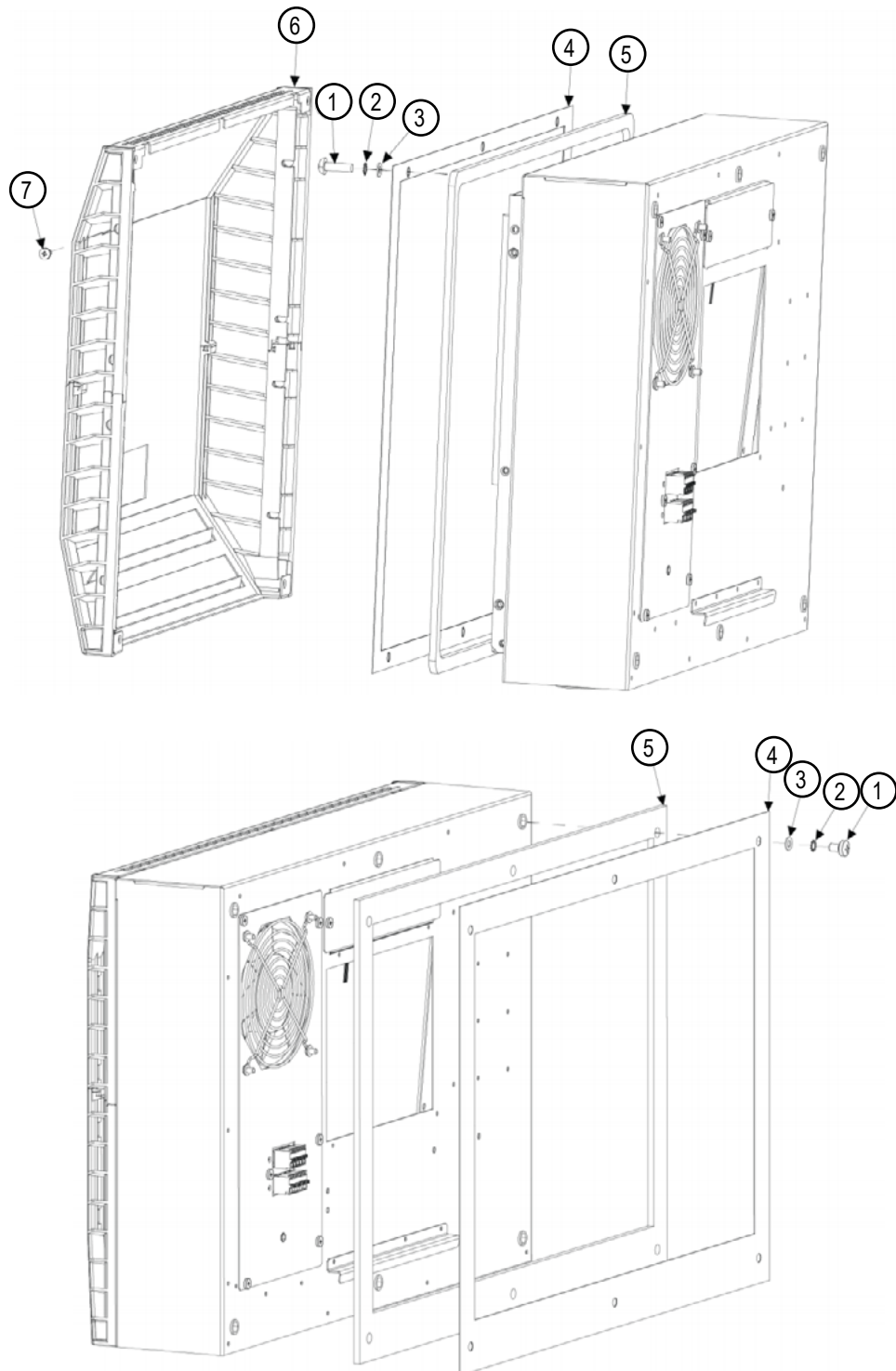

### 10. Cutout Dimensions

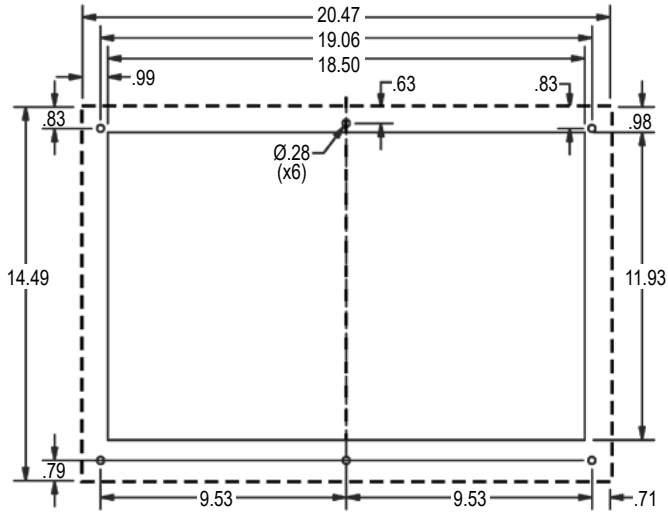

CUTOUT FOR EXTERNAL INSTALLATION

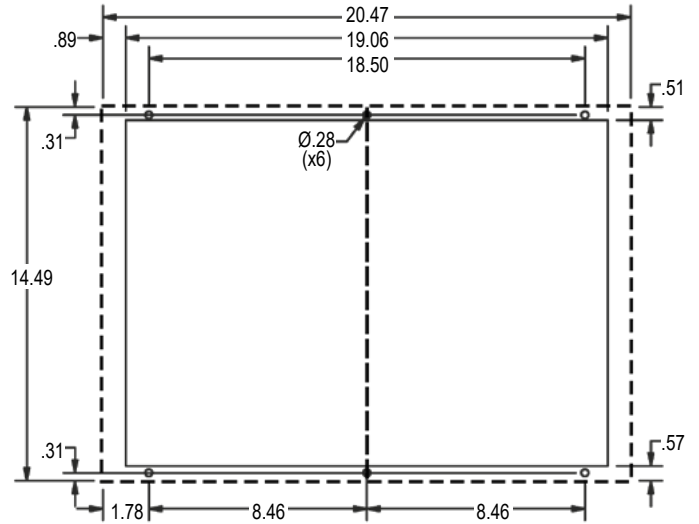

CUTOUT FOR INTERNAL INSTALLATION

### 11. Dimensions (H x W x D)

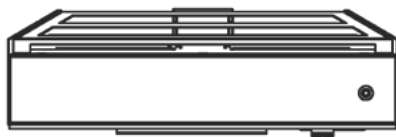
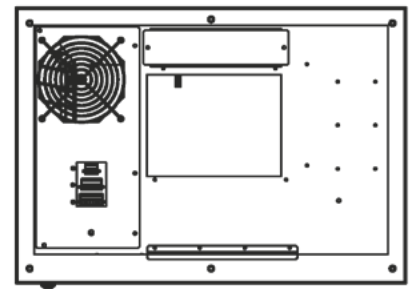
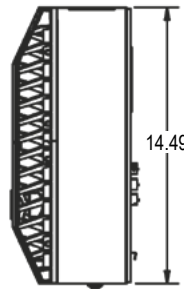
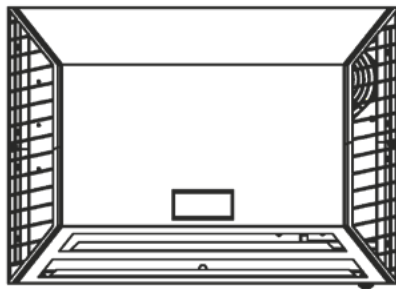
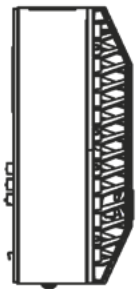
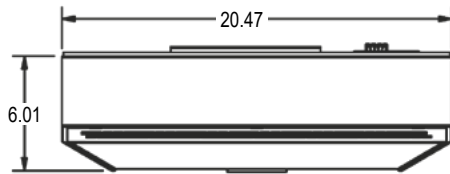

## 12. Electrical Connection



### Caution, risk of death

Unconnected and / or faulty protective conductor systems can lead to dangerous voltages and electric shocks which can cause serious accidents.

Work on electrical connections may only be carried out by trained electrical engineers.

### Alarm Contacts

Alarm contacts ratings:

Maximum switching power 60 W / 125 VA, maximum switching voltage 220 VDC / 250 VAC, maximum switching current 2 A, maximum carrying current 2 A.

These contacts are not suitable for fluorescent loads (neon lights, etc.) that use starters (ballasts) with phase shifting capacitors. Fluorescent lamps with electronic controllers or without phase shifting capacitors can be used, depending on the operating limits specified for each type of relay.

### Strain relief function

In order to maintain the UL listing approval, the supplied strain relief bracket and cable glands must be installed.

### 13A. IR33+ Wiring Diagram

Power Connector	1	L
	2	-
	3	N
	4	PE
Alarms/signals connector	1	Normally closed alarm contact
	2	Alarm contact (COM)
	3	Normally open alarm contact
	4	Door contact
	5	Door contact
RS485 connector	1	A
	2	Gnd
	3	B

**Part List**

- Sa: Ambient Temperature Sensor (Optional)
- Si: Internal Temperature Sensor
- Hcc: Compressor c/case heater (Optional)
- Hce: Condensate evaporator heater
- Hi: Internal heater
- Cc: Compressor capacitor
- Ps: DC Power Supply
- Mc: Compressor
- Ma: Ambient fan
- Mi: Internal fan

**Notes**

See unit typeplate for correct operating voltage and frequency.  
 Suitable protective devices should be installed on the supply line.  
 Use copper conductors only.  
 Use supply wires suitable for (167°F).

1. Connected for units with internal heater. (Optional)

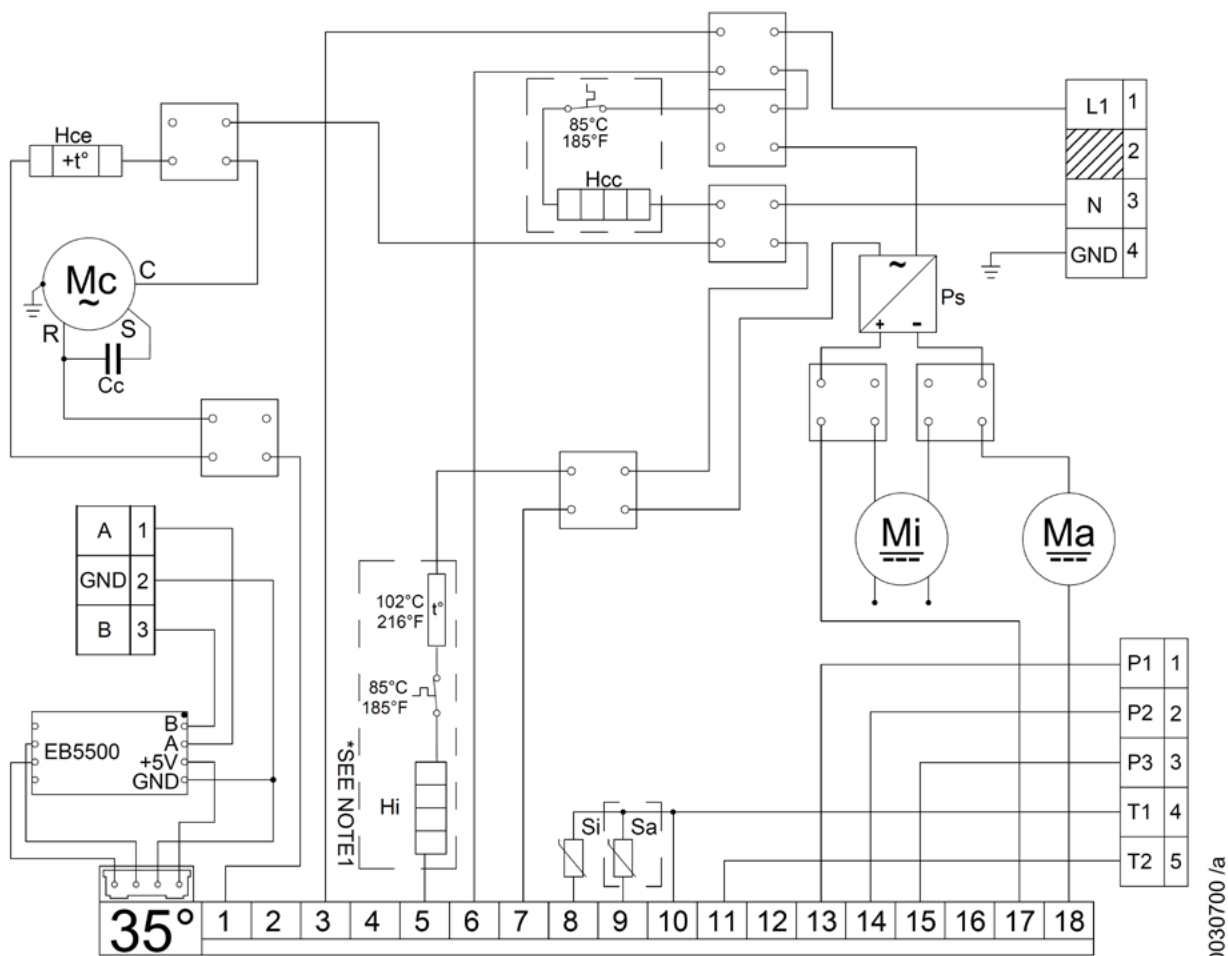

5960030700 /a

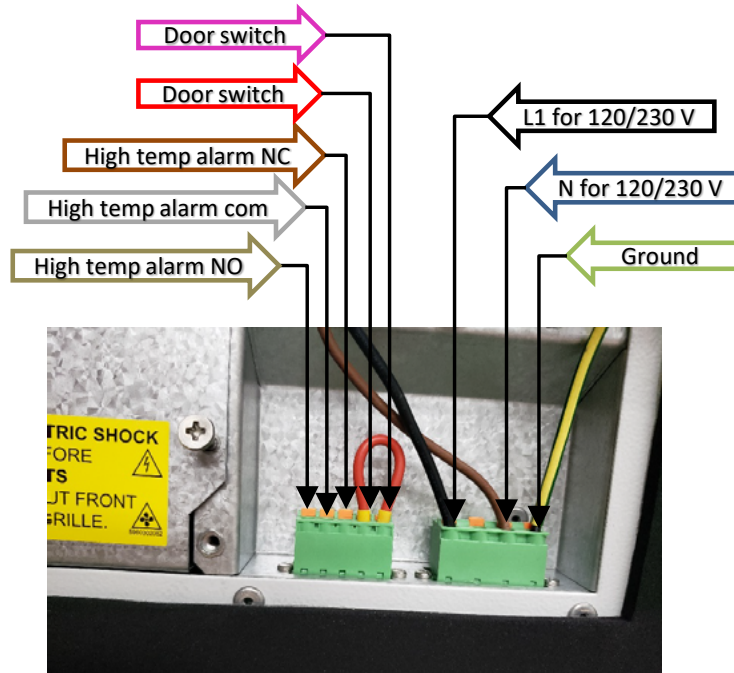

**Notes**

**High temp alarm can be wired NC or NO**

When wires:

P1 P2 – NC

When wires:

P2 P3 - NO

### 13B. DISP-1503 Wiring Diagram

Power Connector	1	L
	2	-
	3	N
	4	PE
Alarms/signals connector	1	Normally closed alarm contact
	2	Alarm contact (COM)
	3	Normally open alarm contact
	4	Door contact
	5	Door contact
RS485 connector	1	A
	2	Gnd
	3	B

**Part List**

- X1: Power connector
- X2: Signals/alarms connector
- X3: Master/slave connector
- Mi: Internal fan
- Ma: Ambient fan
- Mc: Compressor
- Cc: Compressor capacitor
- Si: Internal temperature sensor
- Sa: Ambient temperature sensor
- Hi: Internal heater
- Hc: Compressor crankcase heater
- Ps: 12VDC power supply
- Ce: Condensate Evaporator

**Notes**

1. Use supply wires suitable for (167°F).
2. Use copper conductors only.
3. Optional components in dashed borders.

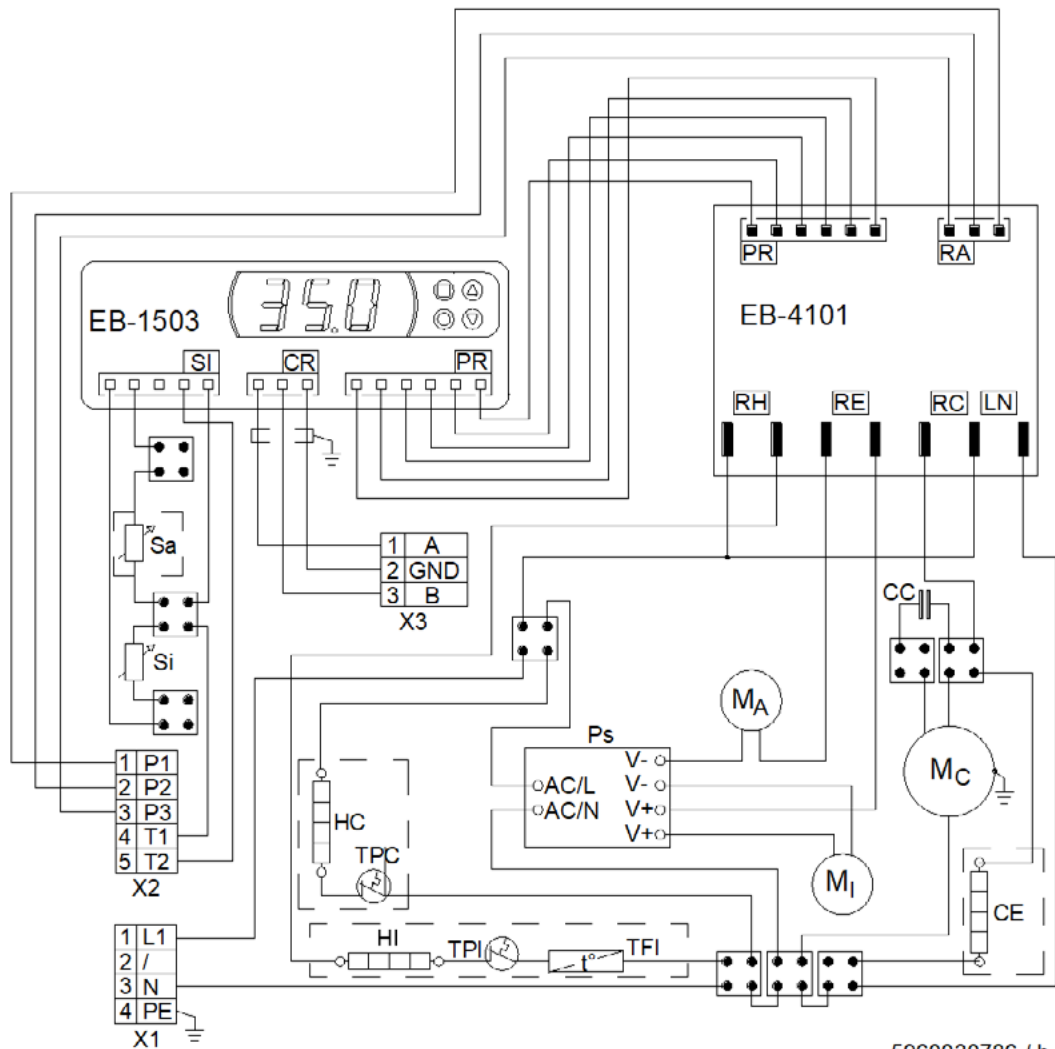

5960030786 / b



## 14. Modbus Connection

Three pole Modbus connector

All Enviro-Therm® units are offered standard with a Modbus connection



SCE-NG1195B / SCE-NG2320B



SCE-NG5100B / SCE-NG6800B  
SCE-NG8500B / SCE-NG14300B

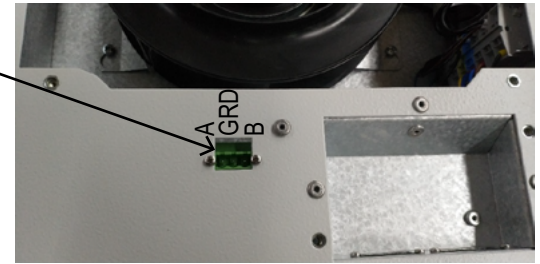

SCE-NG2970B / SCE-NG5290B

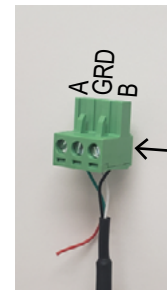

Modbus  
connector  
included

### Relevant Links

Modbus table    SCE-ETHCK setup



Detailed instructions on Modbus communication can be found in the link below  
<https://www.saginawcontrol.com/instman/modbus-table.pdf>

### Further notes:

- From Modbus side, any setting can be with 0.1°C precision. From the display, the precision is 0.5°C. When having a setting, example 30.4°C, this will be rounded to 30.5°C when accessed via display.
- When system detects incorrect sensor mapping, it sends unit into idle and triggers an alarm on display. No alarm is shown on Modbus.
- When Ambient, Icing and Pressure are not enabled, the value displayed (Modbus/Seifert Software) is -50°C.
- When saving settings via communication, S is shown on display for 1 second.
- When system goes in Cooling Mode, C is shown on display for 1 second.
- When system goes in Heating Mode, H is shown on display for 1 second.
- When accessing the Display Settings of Menu 2/3/4, any settings from Modbus are ignored.
- When running a test with the door contact open, the display only shows TEST, since the unit will not be OFF.
- When running a test with Alarms, the Alarms and TEST are shown together.
- On Start-up, the communication is by default Modbus. It can be changed to Seifert Protocol by writing a code in register SET\_CHANGE\_PROTOCOL. After 10 seconds of no communication, system changed back to Modbus.
- When unit is not Modbus Address 1, the Master/Slave and Redundancy parameters are hidden from Menu3 when using Client Password. (MS1, MS2, MdL, rS1, rS2, rS3).
- Enabling the Pressure sensor from Modbus can only be done if the unit is not in cooling mode.
- The Blue LED is ON when the unit is cooling.
- A red LED is ON when the unit is heating.
- The red LED flashes when an alarm is present



## 15. Taking Into Operation

### Attention!

The unit can be damaged by lack of lubricant. To ensure that the compressor is adequately lubricated, the oil, which has been displaced during transport, must first be allowed to flow back into place. The unit must therefore be allowed to stand for at least 30 min. before being connected to the mains and taken into operation.

The unit / system must be protected with a MCB Type D or K. Upon connection the internal fan will start working. If the temperature inside the enclosure is higher than the set value of the controller both the compressor and external air fan start working. The cooling cycle will either stop once the air inside the enclosure reaches the set temperature minus hysteresis or once the minimum On-time is reached.

The hysteresis is 3K, the minimum ON-time is 4 minutes, the minimum OFF-time is 3 minutes, for units with a cooling capacity of more than 1 kW is it usually 7 minutes.

The setpoint for the internal enclosure temperature is pre-set at 95°F.

## 16. Troubleshooting

Failure	Condition	Cause	Solution
<b>Unit Does Not Cool</b>	Internal fan does not work	Power not connected	Verify power supply
	Internal fan works, external fan and compressor do not work	Enclosure temperature is below setting temperature (St)	Verify values of parameter "St"
		Door switch contact is open	Verify door switch
		Controller does not work	Replace controller
	Internal fan works, external fan and compressor do not work Display shows alternating "OFF" and temperature	The sequence of the phases inside the power supply connector is incorrect	Change phases inside power supply connector
	External and internal fan work, compressor does not work	Compressor motor electrical failure	Verify external fan, verify ambient temperature, clean condenser
		Capacitor for compressor failed	Replace capacitor
Compressor works, external fan does not work	External fan needs to be replaced	Replace external fan	
<b>Enclosure Overheating</b>	Compressor and fans (external and internal) work all the time	Unit cooling undersized	Enclosure needs a bigger cooling unit
	Compressor and external fan work in alternating mode (ON / OFF)	Thermal compressor protector triggered	Verify ambient temperature, clean condenser
		Refrigerant leakage	Contact dealer/service center
<b>Excessive Condensate</b>	Door enclosure open	Ambient air gets into the enclosure	Ensure door is closed, add a door switch and connect it to controller
	Door enclosure closed	Enclosure IP degree minimum IP54	Seal openings on enclosure
		Damaged/misplaced sealing strip	Repair strip accordingly



## 17. Maintenance & Cleaning

***Always switch power supply off before starting any maintenance on the unit.  
Wait for 5 minutes for electrical components to discharge.***

The cooling unit is generally maintenance free and can be operated without filters in most environments.

If the ambient air is extremely dusty, we recommend installing filter mats (see accessories). These should be cleaned or replaced at regular intervals. Oily or greasy filter mats should be replaced immediately. Do not use a steam jet or high pressure to clean the filter mats. Do not wring out the filter mats. If the ambient air is extremely oily, we recommend the use of metal filters (see accessories). They can be cleaned with standard cleaning agents and reused. In addition the unit should have regular functional tests (approx every 2,000 hours depending on the grade of ambient pollution).

Note: The use of filter mats / metal filters reduces the cooling capacity of the unit.

### Disposal

The cooling unit contains R134a refrigerant and small quantities of lubricating oil. Replacement, repairs and final disposal must be done according to the regulations of each country for these substances.

## 18. Transportation & Storage

### Malfunction due to transport damage

On delivery the carton box containing the unit must be examined for signs of transport damage. Any transport damage to the carton box could indicate that the unit itself has been damaged in transit which in the worst case could mean that the unit will not function.

The unit can only be stored in locations which meet the following conditions:

- Temperature range: -40°F to 158°F
- Relative humidity (at 77°F): max. 95%
- The cooling unit should always be stored according to the installation position

### Returning the unit

To avoid transport damage the unit should be returned in the original packing or in a packing case and must be strapped to a pallet. If the unit cannot be returned in the original packing please ensure that:

- A space of at least 30 mm must be maintained at all points between the unit and the external packing
- The unit must be shipped in the same position as it was mounted
- The unit must be protected by shock resistant padding (hard foam corner pieces, strips or cardboard corner pieces)

## 19. Parts Supplied

### Parts Supplied:

Full version of instruction manual	
CE declaration of conformity	
1:1 mounting template	
M6 * 16 bolts	x 6
A6.4 toothed washers	x 6
A6.4 washers	x 6
5 - pole terminal block for signals	x 1
4 - pole terminal block for electrical connection	x 1
3 - pole terminal block for RS 485 MODBUS	x 1
Drain fitting	x 1
Foam tape	

## 20. Warranty / Limits of Liability

All goods manufactured by SCE shall be warranted to be free of defects in material or workmanship for a period of two years from the date of shipment. Should the product be proven to SCE to be defective, we shall option to repair or replace the product. At no time will SCE reimburse purchaser for unauthorized rework on any product.

Air Conditioners & Heat Exchangers are warranted on parts and service for a period of two years from the date of shipment by Saginaw Control and subject to the following conditions and exclusions:

All Goods must be installed and operated according to the following specifications: Maximum voltage variation no greater than plus or minus 10% of nominal rating; Maximum frequency variation no greater than plus or minus 3 Hz. from nominal rating; Must not exceed minimum and maximum rated temperatures; Must not exceed (BTU/Hr) rating; Filters must be cleaned regularly; Must be installed and grounded in accordance with all relevant electrical and safety codes, as well as the National Electric Code and OSHA rules and regulations; Must be installed in a stationery application, free of vibration.

Our warranty does not warranty product that has been modified, subjected to abuse, negligence in operation or maintenance, or if product is used in a manner that exceeds its designed capabilities and rating.

Warranty related claims will be returned to the factory for evaluation and final disposition of the claim, any replacement parts will be invoiced at standard pricing and credit issued for the returned product. If the product has been found to have been modified, subjected to abuse, negligence in operation or maintenance, or if product has been used in a manner that exceeds its designed capabilities and rating, credit may be reduced, denied or additional cost may be assessed and passed on to the purchaser, such as return freight.

### Saginaw Control and Engineering

95 Midland Road  
Saginaw, MI 48638-5770  
Phone: (989) 799-6871  
Fax: (989) 799-4524

[sce@saginawcontrol.com](mailto:sce@saginawcontrol.com)

