



User Manual SCE-TE680B24VSS

1. User Manual	p. 2
2. Legal Regulations	p. 2
3. Safety Instructions	p. 3
4. Technical Information	p. 4
5. Functional Principle	p. 4
6. Technical Data	p. 5
7. Performance Graph	p. 6
8. Mounting	p. 7
9. Cutout Dimensions	p. 8
10. Dimensions (H x W x D)	p. 9
11. Electrical Connection	p. 10
12. Wiring Diagram	p. 11
13. Taking Into Operation	p. 12
14. Repair	p. 12
15. Maintenance & Cleaning	p. 12
16. Maintenance	p. 13
17. Transportation & Storage	p. 14
18. Parts Supplied	p. 14
19. Warranty / Limits of Liability	p. 15



1. User Manual

This instruction manual contains information and instructions to enable the user to work safely, correctly and economically on the unit. Understanding and adhering to the manual can help one:

- Avoid any dangers
- Reduce repair costs and stoppages
- Extend and improve the reliability and working life of the unit

PLEASE ENSURE TO USE THE RIGHT VERSION OF THE INSTRUCTION MANUAL SUITABLE FOR YOUR UNIT

Conditions of Use

The unit is to be used exclusively for the dissipation of heat from control cabinets and enclosures in order to protect temperature sensitive components in an industrial environment. To meet the conditions of use, all the information and instructions in the instruction manual must be adhered to.



General Danger

Indicates compulsory safety regulations which are not covered by a specific pictogram such as one of the following.



High Electric Voltage

Indicates electric shock danger.



Important Safety Instruction

Indicates instructions for safe maintenance and operation of the unit.



Attention

Indicates possible burns from hot components.



Attention

Indicates possible damage to the unit.



Instruction

Indicates possible danger to the environment.

2. Legal Regulations

Liability

The information, data and instructions contained in this instruction manual are current at the time of going to press. We reserve the right to make technical changes to the unit in the course of its development. Therefore, no claims can be accepted for previously delivered units based on the information, diagrams or descriptions contained in this manual. No liability can be accepted for damage and production caused by:

- Disregarding the instruction manual
- Operation error
- Inappropriate work on or with the unit
- The use of non-specified spare parts and accessories
- Unauthorized modifications or changes to the unit by the user or his personnel

Saginaw Control & Engineering is only liable for errors and omissions as outlined in the guarantee conditions contained in the main contractual agreement. Claims for damages on any grounds are excluded.

3. Safety Instructions

Upon delivery the unit is already meeting current technical standards, therefore it can be safely taken into operation. Only trained specialists are allowed to work on the unit. Unauthorized personnel must be prohibited from working on the unit. Operating personnel must inform their superiors immediately if any malfunction of the unit becomes apparent.

Please note that before starting to work on or with the unit, a procedure must be carried out inside the cabinet on which the unit is to be mounted.

Before commencing work inside the cabinet, the control cabinet manufacturer's instruction must be read with regards to:

- Safety instructions
- Instructions on taking the cabinet out of operation
- Instructions on the prevention of unauthorized cabinet reconnection

The electric equipment meets the valid safety regulations. One can find dangerous voltage (above 50V AC or above 100V DC):

- Behind the control cabinet doors
- On the power supply in the unit housing

The units have to be fused according to the type plate and the wiring diagram. Switch the unit **off** immediately if the electric power supply is interrupted.



Danger Through Incorrect Work on the Unit

Only specialized personnel are allowed to maintain and clean the unit. Regular maintenance and cleaning must be kept in order to ensure that the unit remains in perfect working condition and has a long working life.



Danger from Electric Voltage

Only specialized personnel are allowed to maintain and clean the unit. The personnel must ensure that for the duration of the maintenance and cleaning, the unit is disconnected from the electrical supply.



Attention

Damage to the unit through the use of inappropriate cleaning materials. Please do not use aggressive cleaning material.



Instruction

Damage to the environment through unauthorized disposal. All spare parts and associated material must be disposed of according to the environmental laws.

4. Technical Information

Peltier cooling units are intended to be used as a complementary accessory to larger industrial equipment. They are used where heat needs to be dissipated from electrical control cabinets or similar enclosures in order to protect heat sensitive components.

Peltier cooling units can dissipate heat from sealed enclosures such as control cabinets. At the same time they can reduce the cabinet internal temperature to below the ambient air temperature. They are available in powder-coated sheet steel or stainless steel housings. Peltier units have additional heating function by changing the supply polarity of the thermoelectric elements. This is possible by using a combination of thermostats or having a specific polarity controller.

Peltier cooling units are resistant to extreme ambient conditions and can operate effectively even in environments which are dusty and oily and where temperatures may vary from -4°F to 149°F. For the cooling capacities and environmental ratings please refer to the type plate data.

5. Functional Principle

Functional Principle

The thermoelectric elements create a temperature difference between the internal and ambient heat sinks, making internal air cooler while dissipating heat into the external environment. Fans help the transfer of convective heat from the heat sinks, which are optimized for maximum flow. Peltier units can be mounted in any position because these units don't have a compressor or any moving parts. Depending on the mounting situation, the condensation management may need to be considered and possibly adjusted.

1. Ambient Fans
2. Ambient Heat Sinks
3. Thermoelectric Elements
4. Insulation
5. Internal Heat Sink
6. Internal Fan

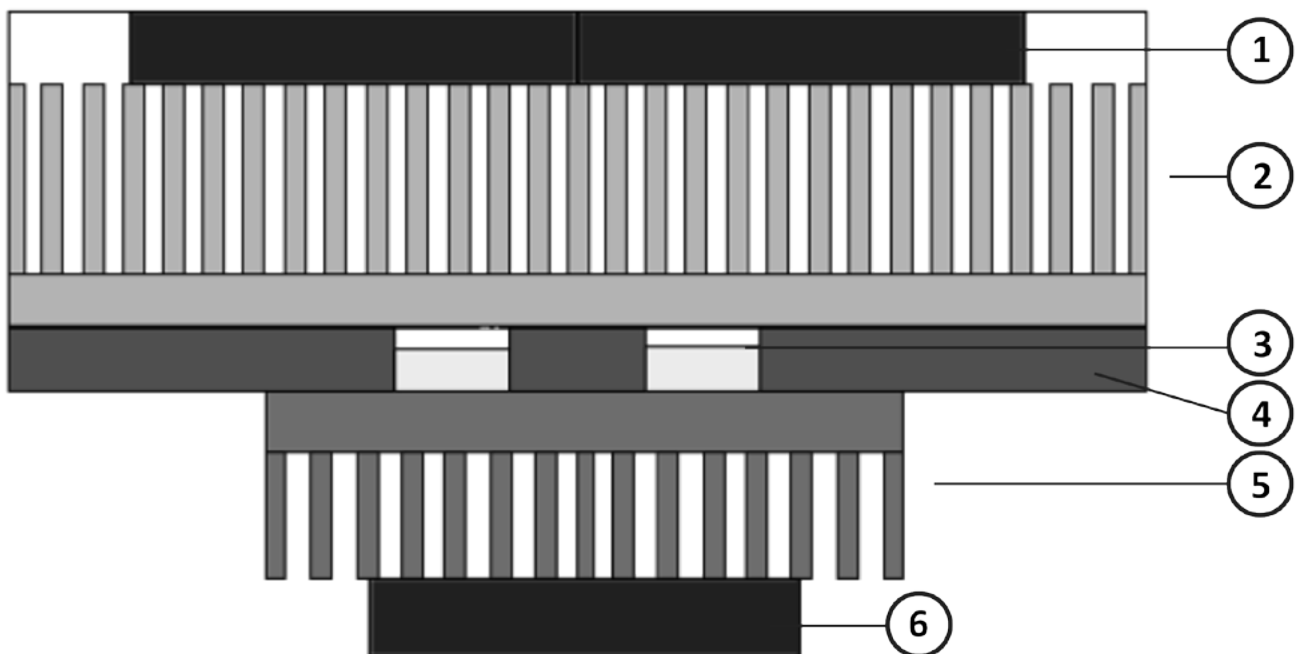

6. Technical Data

Part Number	SCE-TE680B24VSS
Cooling Capacity @ 95°F / 95°F	680 BTU (199 Watts)
Operating Temperature Range	-4°F - 149°F
Air Volume Flow	Ambient Air Circuit: 70 cfm Cabinet Air Circuit: 70 cfm
Mounting	Recessed
Housing Material	Stainless Steel AISI 304
Dimensions (H x W x D)	15.7 x 7.1 x 6.7 inch
Cutout Dimensions	14.60 x 6.10 inch
Weight	22 lbs
Rated Operating Voltage	24V DC
Rated Current	10.8 A
Starting Current	17.0 A
Max Current	11.6 A
Nominal Power @ 95°F / 95°F	260 W
Max Power	280 W
Fuse Rating	16A (T) - Time Delayed [Slow Acting]
Circuit Breaker - MCB Type D or K Slow Acting	16A Slow Acting
Connection	Connection Terminal Block
NEMA Protection Class	NEMA 3, 3R, 4, 4X & 12
Approvals	CE / cURus
Industry Standards	IS20

7. Performance Graph

Thermoelectric Cooler 680 BTU/HR (199 Watts)
Performance Curve
 SCE-TE680B24VSS

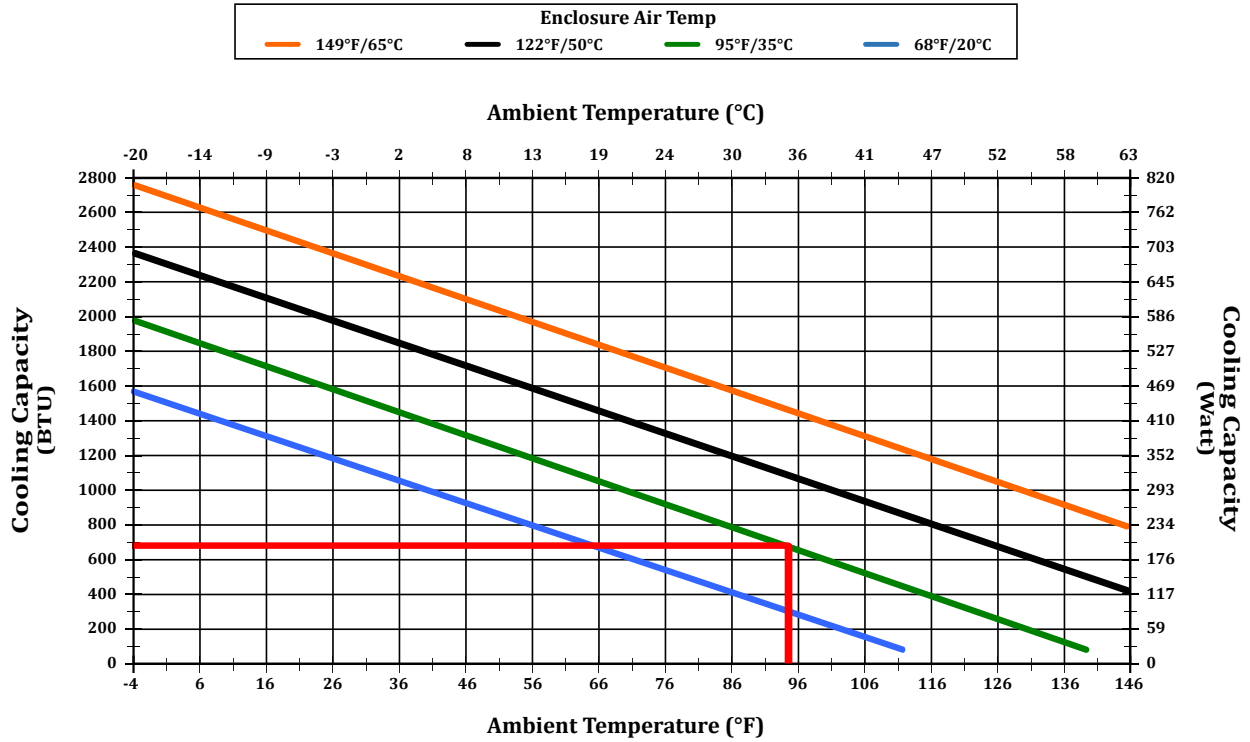

Thermoelectric Cooler 680 BTU/HR (199 Watts)
Heating - Performance Curve
 SCE-TE680B24VSS

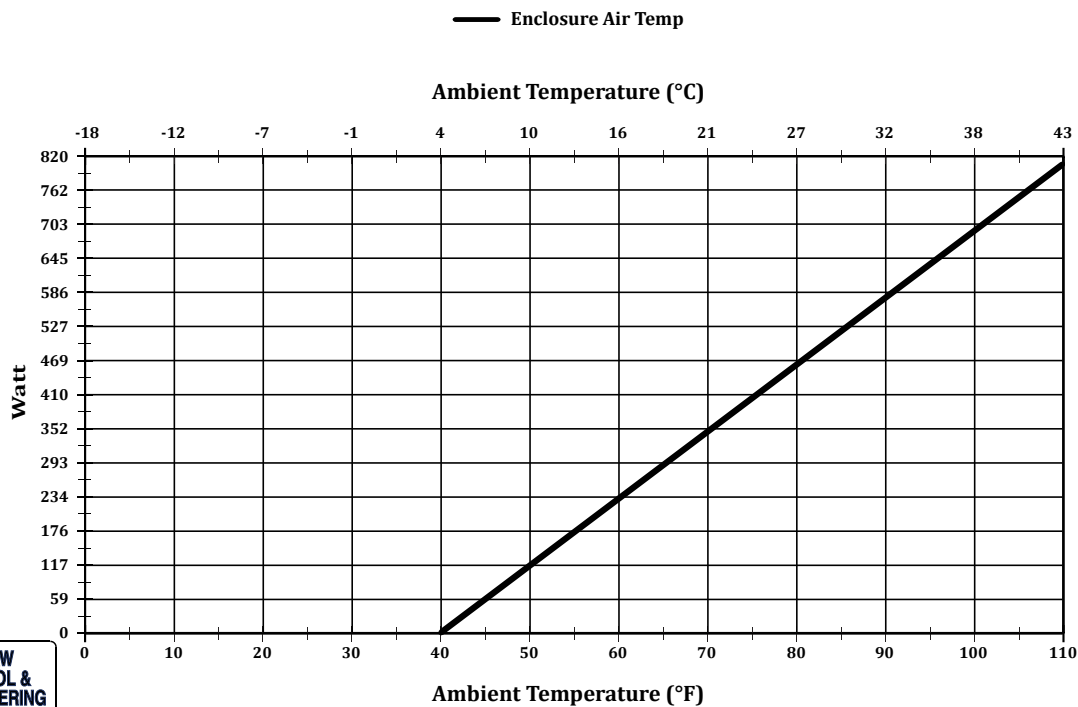

8. Mounting



Always switch off power supply before starting any work on the unit.

Installation

Ensure that flows of air leaving and entering the cooling unit, internal and external, are not obstructed. Before drilling the enclosure, ensure the fixing elements and couplings will not interfere with the equipment inside the enclosure itself. When all mounting preparations are complete, the actual mounting operation can commence. Only use the enclosed material to mount the unit on the cabinet.

Proceed as follows to mount the unit on the enclosure:

- Set the unit up on the enclosure.
- Ensure that the electrical connection is above the internal fan.
- Unit without duct: screw the M6 locknuts & washers into the M6 set screws in the unit.
- Unit with duct: screw the M6 screws & washers into the M6 threaded rivets in the unit.

The resistance of the earth connection between cabinet and cooling unit must be $<0.1 \Omega$.

9. Cutout Dimensions

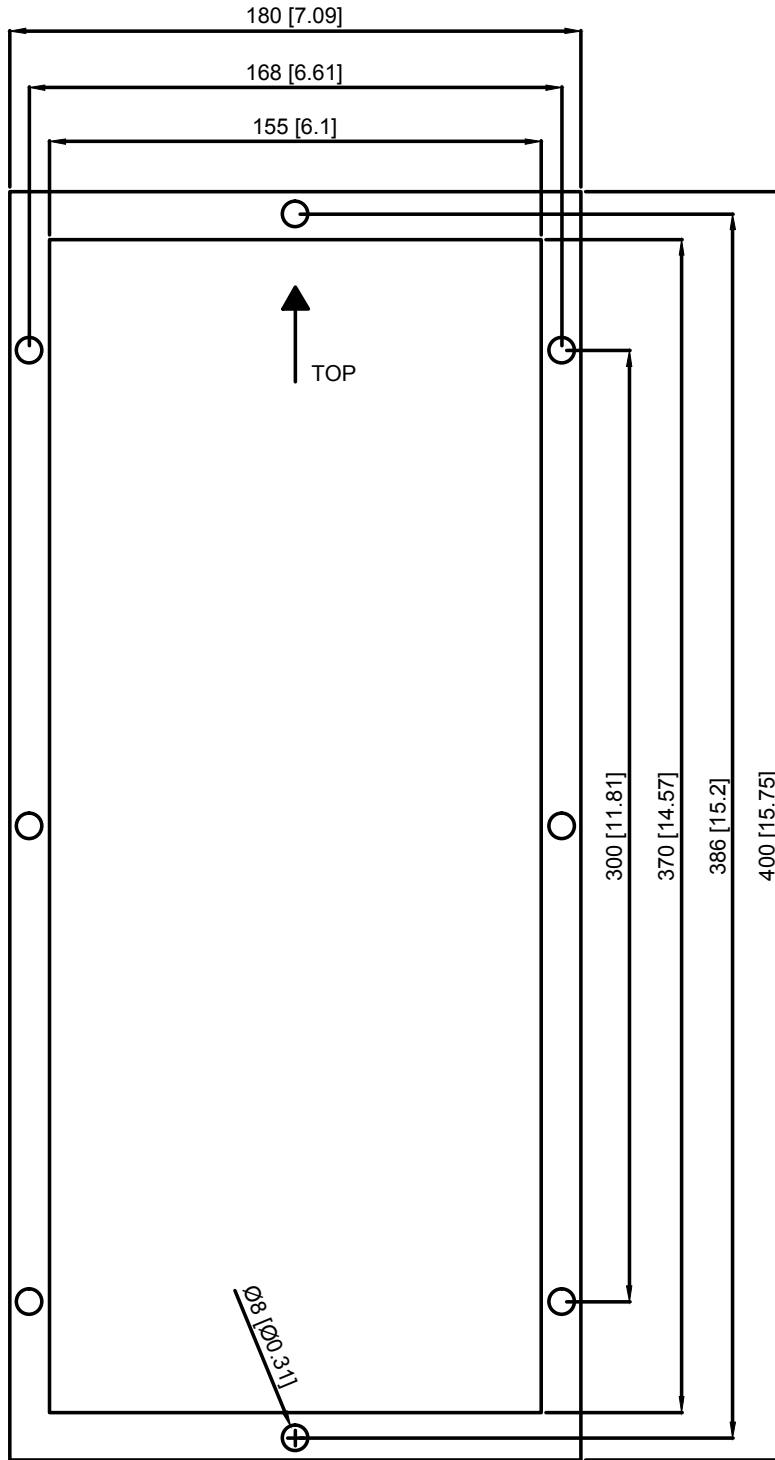

Note:
 Primary dimensions in millimeters.
 Secondary dimensions in inches.

10. Dimensions (H x W x D)

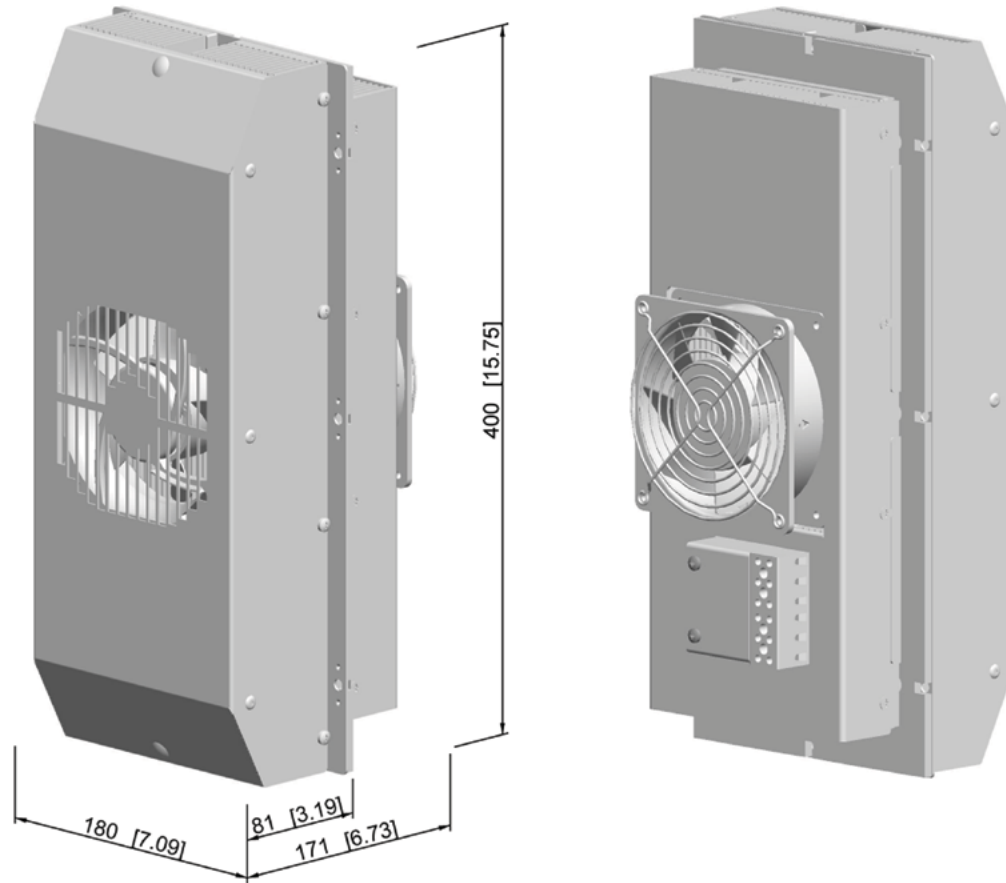

11. Electrical Connection



High electric voltage present.

Installation, maintenance, cleaning and any other work must be carried out by qualified personnel only. The personnel must ensure that for the duration of this work the unit and the cabinet are disconnected from the electrical supply and protected against unauthorized/accidental reconnection.

Instruction

Check that the available voltage, frequency and fuse rating are the same as those stated on the data label.

Connection to the main electricity supply

The mains connection is made via a cable. To connect the unit to the mains supply proceed as follows:

- Disconnect the control cabinet from the mains.
- See the connection details on the circuit diagram.
- Note the connections on the four pole terminal block from the following table:

Terminal 24 V DC

1	Ambient Fan +
2	Ambient Fan –
3	Internal Fan +
4	Internal Fan –
5	Thermoelectric Elements +
6	Thermoelectric Elements –



Ensure that the correct polarity is maintained. The fans should have a clockwise rotation.

- Connect the unit to the mains.
- Take the control cabinet back into operation in the prescribed manner.

Power consumption and start-up current are stated on the data label and under technical data.

12. Wiring Diagram

Thermostat SCE-TEMNO

Part List

- TE Thermoelectric Elements (Peltier)
- IF Internal Fan
- AF Ambient Fan

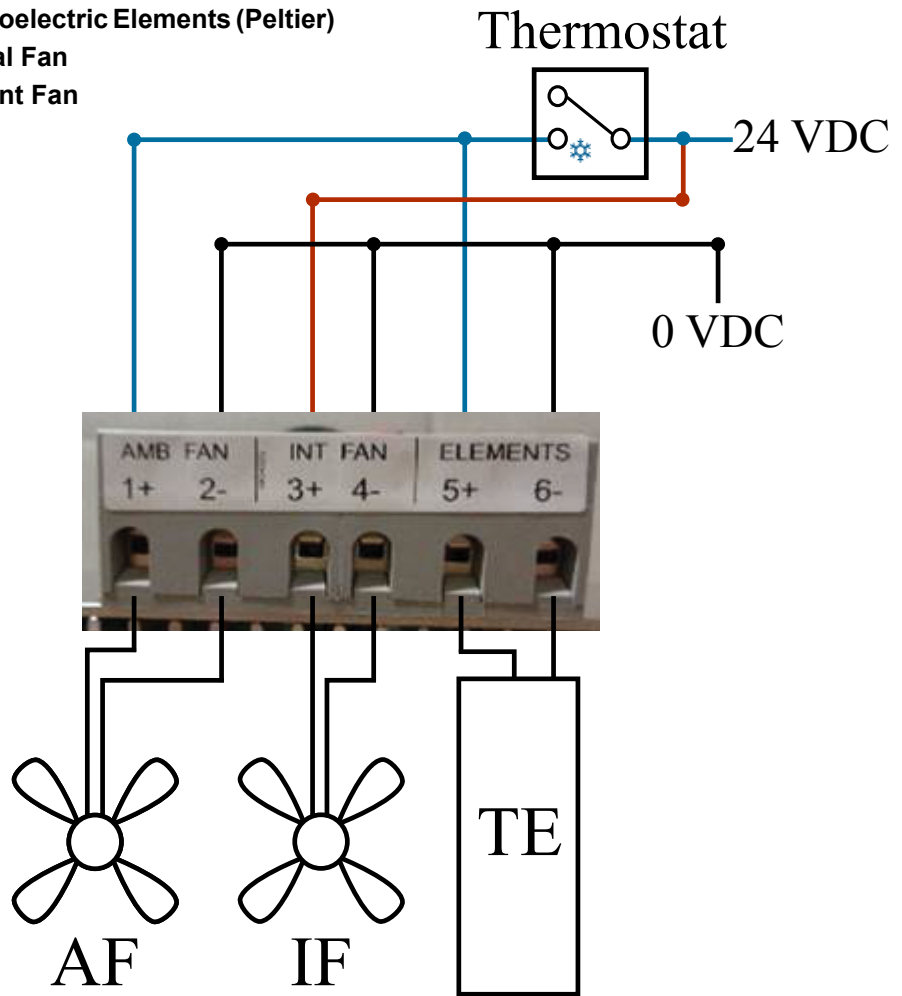

Thermostat SCE-TEMEVDC

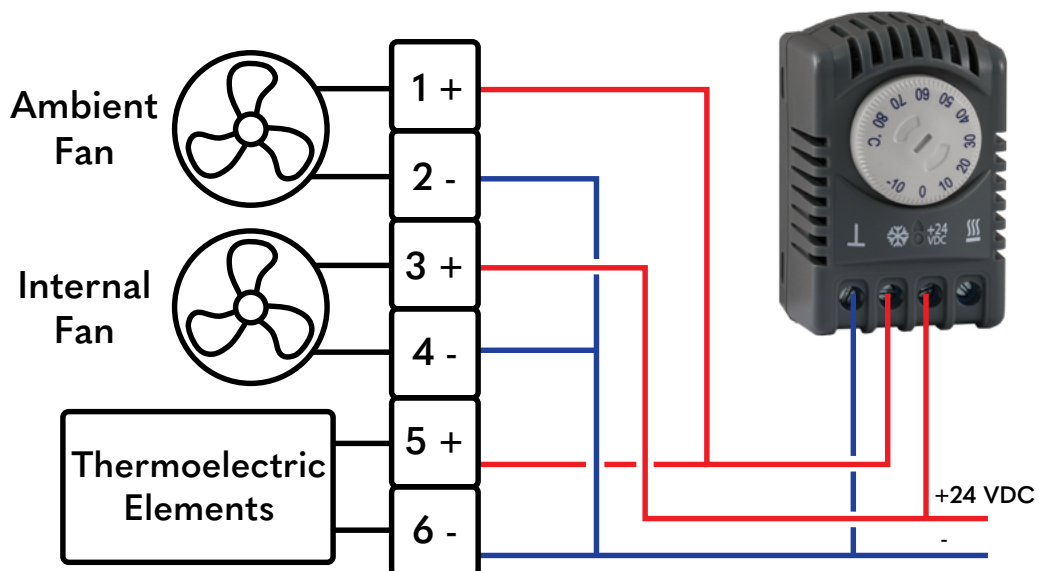

13. Taking Into Operation



The power supply rating on the rating plate must comply with mains supply.



Always disconnect the power supply before opening the unit.

Heat load to be dissipated from enclosure should not exceed specific cooling output of the unit at any condition. While selecting a cooling unit always cater for a safety margin of at least 15% extra cooling output.

The Peltier - elements should be controlled by a suitable thermostat. We recommend the SCE-TEMEVDC Thermostat.

14. Repair

In case of fault Contact Saginaw Control & Engineering - Customer service department at 1-800-234-6871 or E-Mail Customerservice@saginawcontrol.com

15. Maintenance & Cleaning



Always switch off power before starting any work on the unit. Only qualified personnel may conduct any maintenance work on the cooling unit.

All Peltier units are virtually maintenance-free with no filters that need to be cleaned or replaced. Check the ambient heat sinks from time to time. In case they are dirty proceed as following:

- Disconnect the enclosure from the mains.
- Clean the heat sink profile as required by blowing it out with compressed air.
- In cases of extreme pollution wet cleaning is required.



The unit must be removed from the control cabinet for wet cleaning.

Should a wet cleaning be necessary proceed as following:

- Disconnect the whole plant from the mains.
- Remove the unit from the cabinet.
- Ensure that the seals are not damaged.
- Wash the heat sink with an environmentally safe cleaning fluid.



Danger to the environment through unauthorized disposal.

Disposal

Dispose of cooling unit and used parts with due regard for the environment and in accordance with environmental laws and regulations.

16. Maintenance

Note: Only use original replacement parts when repairing the unit. This ensures that the unit functions perfectly and remains safe.

Fan replacement: The average working life of the fan is ca. 40,000 hours under normal conditions. Should a fan replacement be necessary proceed as following:



Danger from Electrical Voltage

Ensure that for the duration of the work the unit and the cabinet are disconnected from the electrical supply and protected against unauthorized reconnection.

- Disconnect the unit from the mains.
- Remove the unit cover.
- Remove the screws from the relevant fan.
- Mount the new fan.



Danger Through Incorrect Work

Make sure that the cabinet fan or the ambient fan are not misplaced in the unit as they are different. Ensure that the correct polarity is maintained. The fans must rotate clockwise!

- Remove the 4 fan fixing screws
- Close the unit and take it back into operation.

17. Transportation & Storage



Malfunction Due to Transport Damage

On delivery the carton containing the unit must be examined for signs of transport damage. Any transport damage to the carton could indicate that the unit itself has been damaged in transit, which in the worst case could mean that the unit will not function.

During transport and storage the cooling unit must be kept in the position marked on the box and at a temperature between -40°F and 158°F and a relative humidity of max. 95% (at 77°F). In case of damaged packaging after transport or in-house handling, we recommend controlling the unit for any internal damages.

18. Parts Supplied

- 1 x Peltier Cooling Unit
- 1 x Instruction Manual
- 1 x CE Conformity Declaration
- 8 x Screws M6*10
- 8 x M6 Nuts
- 8 x Washers
- 2 x Plastic Dummy Plugs

Saginaw Control and Engineering

95 Midland Road
Saginaw, MI 48638-5770

Phone: (989) 799-6871

Fax: (989) 799-4524

sce@saginawcontrol.com

19. Warranty / Limits of Liability

All goods manufactured by SCE shall be warranted to be free of defects in material or workmanship for a period of two years from the date of shipment. Should the product be proven to SCE to be defective, we shall option to repair or replace the product. At no time will SCE reimburse purchaser for unauthorized rework on any product.

Air Conditioners & Heat Exchangers are warranted on parts and service for a period of two years from the date of shipment by Saginaw Control and subject to the following conditions and exclusions:

All Goods must be installed and operated according to the following specifications: Maximum voltage variation no greater than plus or minus 10% of nominal rating; Maximum frequency variation no greater than plus or minus 3 Hz. from nominal rating; Must not exceed minimum and maximum rated temperatures; Must not exceed (BTU/Hr) rating; Filters must be cleaned regularly; Must be installed and grounded in accordance with all relevant electrical and safety codes, as well as the National Electric Code and OSHA rules and regulations; Must be installed in a stationery application, free of vibration.

Our warranty does not warranty product that has been modified, subjected to abuse, negligence in operation or maintenance, or if product is used in a manner that exceeds its designed capabilities and rating.

Warranty related claims will be returned to the factory for evaluation and final disposition of the claim, any replacement parts will be invoiced at standard pricing and credit issued for the returned product. If the product has been found to have been modified, subjected to abuse, negligence in operation or maintenance, or if product has been used in a manner that exceeds its designed capabilities and rating, credit may be reduced, denied or additional cost may be assessed and passed on to the purchaser, such as return freight.